

## Papillon barrier



Barrier in 50x30 mm section rectangular tubular steel, L=2000, embedded.



Specifications: Barrier in 50x30 mm rectangular tubular non-alloy steel with curved bars crossing at the centre, ideal for both historic and modern city centres. The original shape makes the barrier easy to locate in any urban context, creating an ideal strong barrier between pedestrian and traffic zones. Available in either galvanised and painted version, with base plate or embedded. Overall dimensions base plated model: 2000x50x1000h mm. Overall dimensions embedded model: 2000x50x1200h mm. Indicative weight: 17 kg.

### General Product Information

<b>Code</b>	230510
<b>Applications</b>	Barrier with minimalist style to fit in with all contexts, from historic city centres to all types of urban area.
<b>Installation</b>	Embedded base anchored to the ground. Make sure it is fixed to a suitable surface.
<b>Notes</b>	

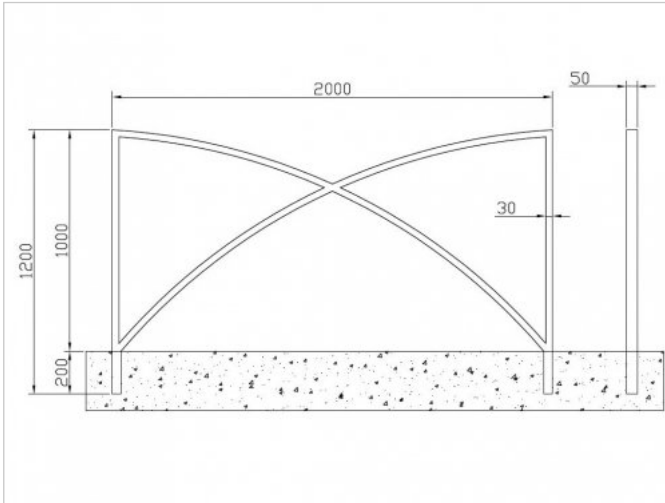
### Data sheet



<b>Colour</b>	RAL colours as per catalogue 
<b>Materials</b>	Galvanised and painted steel 
<b>Dimensions</b>	Width 50 mm Length 2000 mm Height 1200 mm (1000 mm above ground)
<b>Weight</b>	17 Kg

## Papillon barrier





Barrier in 50x30 mm section rectangular tubular steel, L=2000, base plated.

Specifications: Barrier in 50x30 mm rectangular tubular non-alloy steel with curved bars crossing at the centre, ideal for both historic and modern city centres. The original shape makes the barrier easy to locate in any urban context, creating an ideal strong barrier between pedestrian and traffic zones. Available in either galvanised and painted version, with base plate or embedded. Overall dimensions base plated model: 2000x50x1000h mm. Overall dimensions embedded model: 2000x50x1200h mm. Indicative weight: 17 kg.

### General Product Information

<b>Code</b>	230520
<b>Applications</b>	Barrier with minimalist style to fit in with all contexts, from historic city centres to all types of urban area.
<b>Installation</b>	Base plate anchored to the ground. Make sure it is fixed to a suitable surface.
<b>Notes</b>	

### Data sheet

<b>Colour</b>	RAL colours as per catalogue 
<b>Materials</b>	Galvanised and painted steel 
<b>Dimensions</b>	Width 50 mm Length 2000 mm Height 1000 mm
<b>Weight</b>	17 Kg

## Papillon barrier



Barrier in 50x30 mm section rectangular tubular steel, L=1000, embedded.

Specifications: Barrier in 50x30 mm rectangular tubular non-alloy steel with curved bars crossing at the centre, ideal for both historic and modern city centres. The original shape makes the barrier easy to locate in any urban context, creating an ideal strong barrier between pedestrian and traffic zones. Available in either galvanised and painted version, with base plate or embedded. Overall dimensions base plated model: 2000x50x1000h mm. Overall dimensions embedded model: 2000x50x1200h mm. Indicative weight: 17 kg.

### General Product Information

<b>Code</b>	250067
<b>Applications</b>	Barrier with minimalist style to fit in with all contexts, from historic city centres to all types of urban area.
<b>Installation</b>	Embedded base anchored to the ground. Make sure it is fixed to a suitable surface.
<b>Notes</b>	

### Data sheet

<b>Colour</b>	RAL colours as per catalogue 
<b>Materials</b>	Galvanised and painted steel 
<b>Dimensions</b>	Width 50 mm Length 1000 mm Height 1200 mm (1000 mm above ground)
<b>Weight</b>	17 Kg

## Papillon barrier





Barrier in 50x30 mm section rectangular tubular steel, L=1000 base plated.

### General Product Information

<b>Code</b>	250094
<b>Applications</b>	Barrier with minimalist style to fit in with all contexts, from historic city centres to all types of urban area.
<b>Installation</b>	Base plate anchored to the ground. Make sure it is fixed to a suitable surface.
<b>Notes</b>	

### Data sheet

<b>Colour</b>	RAL colours as per catalogue 
<b>Materials</b>	Galvanised and painted steel 
<b>Dimensions</b>	Width 50 mm Length 1000 mm Height 1000 mm
<b>Weight</b>	17 Kg